

FACTSHEET

1730 Dining Chair

MATERIALS

IRON / Used in solid rod form or tube, hand-welded. Finished with Zinc primer and powder coated. Now introducing a double coat to enhance durability and performance.

PVC / Our star material. Ideal for outdoors. Made with a percentage of recycled material, and also 100% recyclable. With added UV filters that protect color from fast-fading under the sun. It does not become dry or breakable, keeps its flexibility. Non-flammable, easy to clean.

FABRIC CORD / Synthetic nylon cord, highly weather resistant, rain or shine. Stays soft to the touch while providing great support.

FABRIC / We use Sunbrella fabric to cover our cushions. These fabrics are made from 100% solution-dyed acrylic, which make them breathable as well as UV, water, mildew and stain resistant.
Resistant to humidity and sunlight

PALM FIBER / The palm fiber we use at Mexa is specially harvested from the Mexican pacific coastline. This rope is specially threaded by twisting and interlocking the largest leaves while applying a certain amount of moisture. This material gives our pieces a very warm look and feel. **Please note: our natural palm fiber is an indoor material.**

SYNTHETIC PALM FIBER / is made out of polyethylene raw material, which was specially developed for furniture use and it stands really well in the elements. Its variety of brown tones make it look and feel like natural fiber, but with the capacity to be used in the outdoors.
Resistant to humidity and sunlight

Color Powder Coating

Indoor and outdoor use



PVC

Indoor and outdoor use

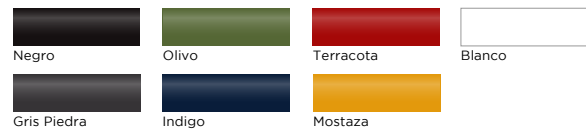

Fabric

Indoor and outdoor use

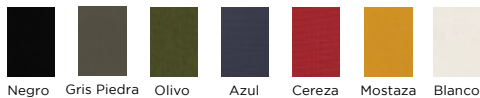

Fabric Cord

Indoor and outdoor use 7mm

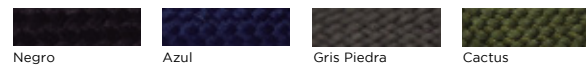

Natural Palm

Indoor use



Synthetic Palm

Indoor and outdoor use



DIMENSIONS

H 88cm / 34.5"
L 58.4cm / 23"
W 51.5cm / 20"
7.3 kg / 16.1 lb

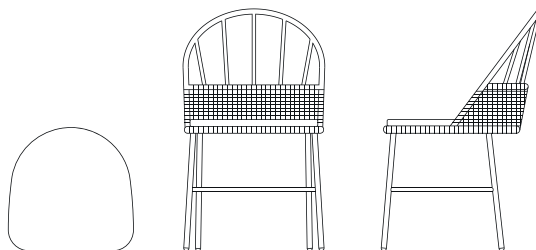

*The finished product may vary from the one on the image, depending on the combinations of materials and colors.

FACTSHEET

1730 Dining Armchair

MATERIALS

IRON / Used in solid rod form or tube, hand-welded. Finished with Zinc primer and powder coated. Now introducing a double coat to enhance durability and performance.

PVC / Our star material. Ideal for outdoors. Made with a percentage of recycled material, and also 100% recyclable. With added UV filters that protect color from fast-fading under the sun. It does not become dry or breakable, keeps its flexibility. Non-flammable, easy to clean.

FABRIC CORD / Synthetic nylon cord, highly weather resistant, rain or shine. Stays soft to the touch while providing great support.

FABRIC / We use Sunbrella fabric to cover our cushions. These fabrics are made from 100% solution-dyed acrylic, which make them breathable as well as UV, water, mildew and stain resistant.
Resistant to humidity and sunlight

PALM FIBER / The palm fiber we use at Mexa is specially harvested from the Mexican pacific coastline. This rope is specially threaded by twisting and interlocking the largest leaves while applying a certain amount of moisture. This material gives our pieces a very warm look and feel. **Please note: our natural palm fiber is an indoor material.**

SYNTHETIC PALM FIBER / is made out of polyethylene raw material, which was specially developed for furniture use and it stands really well in the elements. Its variety of brown tones make it look and feel like natural fiber, but with the capacity to be used in the outdoors.
Resistant to humidity and sunlight

Color Powder Coating

Indoor and outdoor use



PVC

Indoor and outdoor use

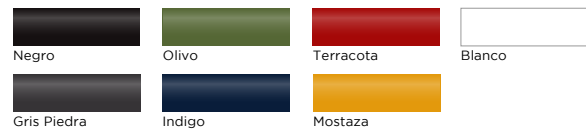

Fabric

Indoor and outdoor use

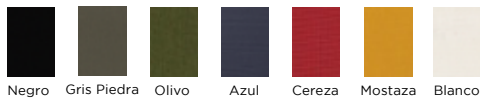

Fabric Cord

Indoor and outdoor use 7mm

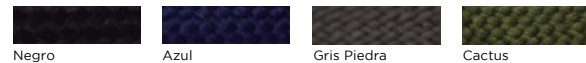

Natural Palm

Indoor use



Synthetic Palm

Indoor and outdoor use



DIMENSIONS

H 88cm / 34.5"
L 58.4cm / 23"
W 54.5cm / 21.5"
9.4 kg / 20.7 lb

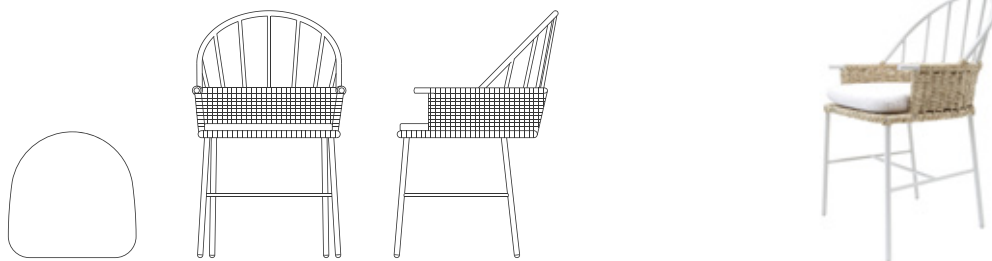

*The finished product may vary from the one on the image, depending on the combinations of materials and colors.

FACTSHEET

1730 Bar Stool

MATERIALS

IRON / Used in solid rod form or tube, hand-welded. Finished with Zinc primer and powder coated. Now introducing a double coat to enhance durability and performance.

PVC / Our star material. Ideal for outdoors. Made with a percentage of recycled material, and also 100% recyclable. With added UV filters that protect color from fast-fading under the sun. It does not become dry or breakable, keeps its flexibility. Non-flammable, easy to clean.

FABRIC CORD / Synthetic nylon cord, highly weather resistant, rain or shine. Stays soft to the touch while providing great support.

FABRIC / We use Sunbrella fabric to cover our cushions. These fabrics are made from 100% solution-dyed acrylic, which make them breathable as well as UV, water, mildew and stain resistant.
Resistant to humidity and sunlight

PALM FIBER / The palm fiber we use at Mexa is specially harvested from the Mexican pacific coastline. This rope is specially threaded by twisting and interlocking the largest leaves while applying a certain amount of moisture. This material gives our pieces a very warm look and feel. **Please note: our natural palm fiber is an indoor material.**

SYNTHETIC PALM FIBER / is made out of polyethylene raw material, which was specially developed for furniture use and it stands really well in the elements. Its variety of brown tones make it look and feel like natural fiber, but with the capacity to be used in the outdoors.
Resistant to humidity and sunlight

Color Powder Coating

Indoor and outdoor use

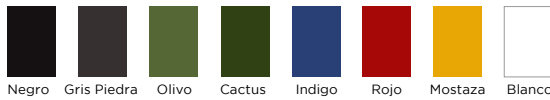

PVC

Indoor and outdoor use

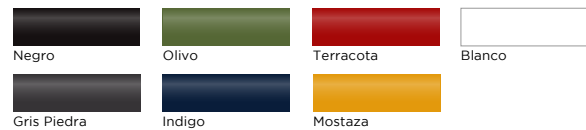

Fabric

Indoor and outdoor use

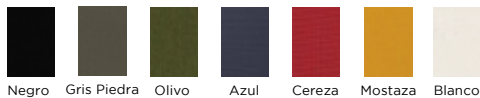

Fabric Cord

Indoor and outdoor use 7mm

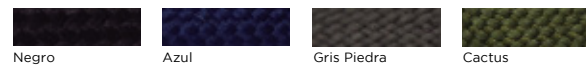

Natural Palm

Indoor use



Synthetic Palm

Indoor and outdoor use



DIMENSIONS

H 106cm / 42"

L 59cm / 23"

W 56cm / 22"

9.6 kg / 21.2 lb

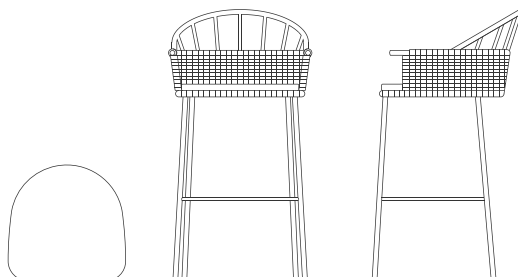

*The finished product may vary from the one on the image, depending on the combinations of materials and colors.

FACTSHEET

1730 Coffee Table

MATERIALS

IRON / Used in solid rod form or tube, hand-welded. Finished with Zinc primer and powder coated. Now introducing a double coat to enhance durability and performance.

WOOD / We use certified Cumarú hardwood, a highly resistant type of wood, similar to teak. With a natural oil finish.

Color Powder Coating

Indoor and outdoor use



Wood

Indoor and outdoor use



DIMENSIONS

H 40.5cm / 16"
L 77cm / 30"
W 77cm / 30"
12.6 kg / 27.8 lb

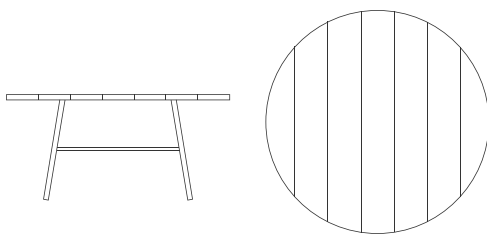

*The finished product may vary from the one on the image, depending on the combinations of materials and colors.

FACTSHEET

1730 Counter Stool

MATERIALS

IRON / Used in solid rod form or tube, hand-welded. Finished with Zinc primer and powder coated. Now introducing a double coat to enhance durability and performance.

PVC / Our star material. Ideal for outdoors. Made with a percentage of recycled material, and also 100% recyclable. With added UV filters that protect color from fast-fading under the sun. It does not become dry or breakable, keeps its flexibility. Non-flammable, easy to clean.

FABRIC CORD / Synthetic nylon cord, highly weather resistant, rain or shine. Stays soft to the touch while providing great support.

FABRIC / We use Sunbrella fabric to cover our cushions. These fabrics are made from 100% solution-dyed acrylic, which make them breathable as well as UV, water, mildew and stain resistant.
Resistant to humidity and sunlight

PALM FIBER / The palm fiber we use at Mexa is specially harvested from the Mexican pacific coastline. This rope is specially threaded by twisting and interlocking the largest leaves while applying a certain amount of moisture. This material gives our pieces a very warm look and feel. **Please note: our natural palm fiber is an indoor material.**

SYNTHETIC PALM FIBER / is made out of polyethylene raw material, which was specially developed for furniture use and it stands really well in the elements. Its variety of brown tones make it look and feel like natural fiber, but with the capacity to be used in the outdoors.
Resistant to humidity and sunlight

Color Powder Coating

Indoor and outdoor use



PVC

Indoor and outdoor use

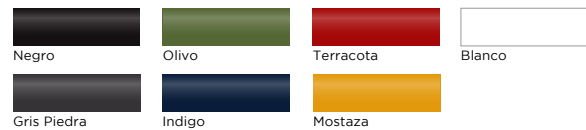

Fabric

Indoor and outdoor use

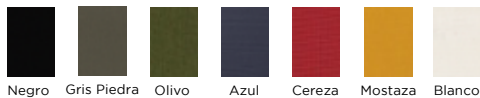

Fabric Cord

Indoor and outdoor use 7mm

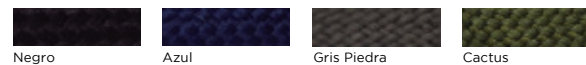

Natural Palm

Indoor use



Synthetic Palm

Indoor and outdoor use



DIMENSIONS

H 100cm / 39.5"

L 58cm / 23"

W 56cm / 22"

9.4 kg / 20.7 lb

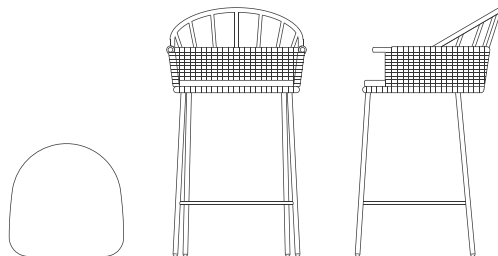

*The finished product may vary from the one on the image, depending on the combinations of materials and colors.

FACTSHEET

1730 Lounge Chair

MATERIALS

IRON / Used in solid rod form or tube, hand-welded. Finished with Zinc primer and powder coated. Now introducing a double coat to enhance durability and performance.

PVC / Our star material. Ideal for outdoors. Made with a percentage of recycled material, and also 100% recyclable. With added UV filters that protect color from fast-fading under the sun. It does not become dry or breakable, keeps its flexibility. Non-flammable, easy to clean.

FABRIC CORD / Synthetic nylon cord, highly weather resistant, rain or shine. Stays soft to the touch while providing great support.

FABRIC / We use Sunbrella fabric to cover our cushions. These fabrics are made from 100% solution-dyed acrylic, which make them breathable as well as UV, water, mildew and stain resistant.
Resistant to humidity and sunlight

PALM FIBER / The palm fiber we use at Mexa is specially harvested from the Mexican pacific coastline. This rope is specially threaded by twisting and interlocking the largest leaves while applying a certain amount of moisture. This material gives our pieces a very warm look and feel. **Please note: our natural palm fiber is an indoor material.**

SYNTHETIC PALM FIBER / is made out of polyethylene raw material, which was specially developed for furniture use and it stands really well in the elements. Its variety of brown tones make it look and feel like natural fiber, but with the capacity to be used in the outdoors.
Resistant to humidity and sunlight

Color Powder Coating

Indoor and outdoor use



PVC

Indoor and outdoor use

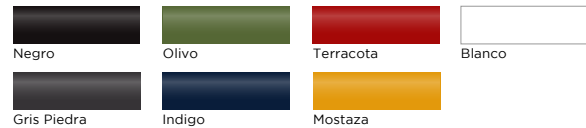

Fabric

Indoor and outdoor use



Fabric Cord

Indoor and outdoor use 7mm

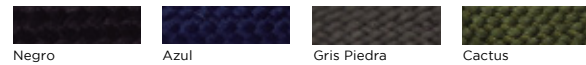

Natural Palm

Indoor use



Synthetic Palm

Indoor and outdoor use



DIMENSIONS

H 86.5cm / 34"
L 67cm / 26.5"
W 66cm / 26"
12.5 kg / 27.6 lb

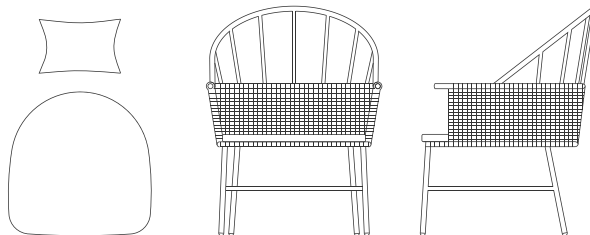

*The finished product may vary from the one on the image, depending on the combinations of materials and colors.

mexa

FACTSHEET

1730 Loveseat

MATERIALS

IRON / Used in solid rod form or tube, hand-welded. Finished with Zinc primer and powder coated. Now introducing a double coat to enhance durability and performance.

PVC / Our star material. Ideal for outdoors. Made with a percentage of recycled material, and also 100% recyclable. With added UV filters that protect color from fast-fading under the sun. It does not become dry or breakable, keeps its flexibility. Non-flammable, easy to clean.

FABRIC CORD / Synthetic nylon cord, highly weather resistant, rain or shine. Stays soft to the touch while providing great support.

FABRIC / We use Sunbrella fabric to cover our cushions. These fabrics are made from 100% solution-dyed acrylic, which make them breathable as well as UV, water, mildew and stain resistant.
Resistant to humidity and sunlight

PALM FIBER / The palm fiber we use at Mexa is specially harvested from the Mexican pacific coastline. This rope is specially threaded by twisting and interlocking the largest leaves while applying a certain amount of moisture. This material gives our pieces a very warm look and feel. **Please note: our natural palm fiber is an indoor material.**

SYNTHETIC PALM FIBER / is made out of polyethylene raw material, which was specially developed for furniture use and it stands really well in the elements. Its variety of brown tones make it look and feel like natural fiber, but with the capacity to be used in the outdoors.
Resistant to humidity and sunlight

Color Powder Coating

Indoor and outdoor use



PVC

Indoor and outdoor use

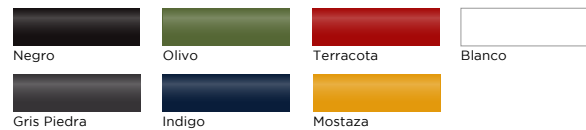

Fabric

Indoor and outdoor use

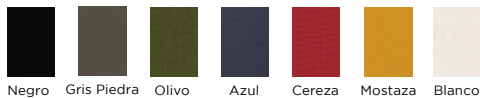

Fabric Cord

Indoor and outdoor use 7mm

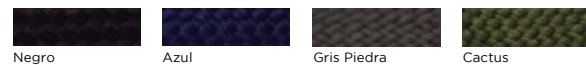

Natural Palm

Indoor use



Synthetic Palm

Indoor and outdoor use



DIMENSIONS

H 82cm / 32"
L 154.5cm / 61"
W 73.5cm / 29"
23.4 kg / 51.5 lb

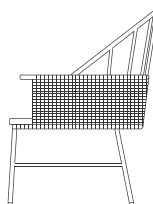
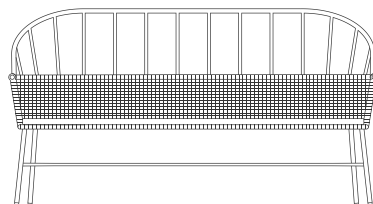

*The finished product may vary from the one on the image, depending on the combinations of materials and colors.

FACTSHEET

1730 Rocking Chair

MATERIALS

IRON / Used in solid rod form or tube, hand-welded. Finished with Zinc primer and powder coated. Now introducing a double coat to enhance durability and performance.

PVC / Our star material. Ideal for outdoors. Made with a percentage of recycled material, and also 100% recyclable. With added UV filters that protect color from fast-fading under the sun. It does not become dry or breakable, keeps its flexibility. Non-flammable, easy to clean.

FABRIC CORD / Synthetic nylon cord, highly weather resistant, rain or shine. Stays soft to the touch while providing great support.

FABRIC / We use Sunbrella fabric to cover our cushions. These fabrics are made from 100% solution-dyed acrylic, which make them breathable as well as UV, water, mildew and stain resistant.
Resistant to humidity and sunlight

PALM FIBER / The palm fiber we use at Mexa is specially harvested from the Mexican pacific coastline. This rope is specially threaded by twisting and interlocking the largest leaves while applying a certain amount of moisture. This material gives our pieces a very warm look and feel. **Please note: our natural palm fiber is an indoor material.**

SYNTHETIC PALM FIBER / is made out of polyethylene raw material, which was specially developed for furniture use and it stands really well in the elements. Its variety of brown tones make it look and feel like natural fiber, but with the capacity to be used in the outdoors.
Resistant to humidity and sunlight

Color Powder Coating

Indoor and outdoor use

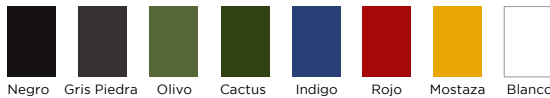

PVC

Indoor and outdoor use

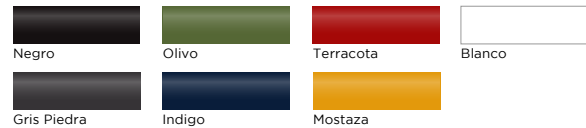

Fabric

Indoor and outdoor use

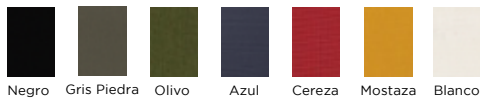

Fabric Cord

Indoor and outdoor use 7mm

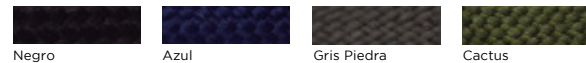

Natural Palm

Indoor use



Synthetic Palm

Indoor and outdoor use



DIMENSIONS

H 85cm / 33.5"
L 90cm / 35.5"
W 67cm / 26.5"
16.9 kg / 37.3 lb

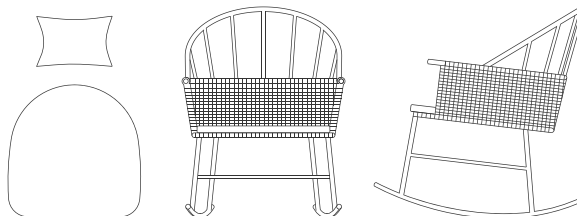

*The finished product may vary from the one on the image, depending on the combinations of materials and colors.

FACTSHEET

1730 Side Table

MATERIALS

IRON / Used in solid rod form or tube, hand-welded. Finished with Zinc primer and powder coated. Now introducing a double coat to enhance durability and performance.

WOOD / We use certified Cumarú hardwood, a highly resistant type of wood, similar to teak. With a natural oil finish.

Color Powder Coating

Indoor and outdoor use



Wood

Indoor and outdoor use



Cumarú

DIMENSIONS

H 45.5cm / 18"
L 55cm / 21.5"
W 55cm / 21.5"
7.8 kg / 17.2 lb

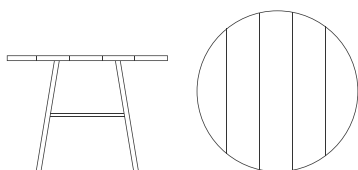

*The finished product may vary from the one on the image, depending on the combinations of materials and colors.

FACTSHEET

1730 Square Dining Table

MATERIALS

IRON / Used in solid rod form or tube, hand-welded. Finished with Zinc primer and powder coated. Now introducing a double coat to enhance durability and performance.

WOOD / We use certified Cumarú hardwood, a highly resistant type of wood, similar to teak. With a natural oil finish.

Color Powder Coating

Indoor and outdoor use



Wood

Indoor and outdoor use

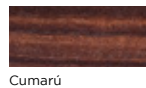

DIMENSIONS

H 76.4cm / 30"
L 88cm / 34.5"
W 88cm / 34.5"
24.2 kg / 53.4 lb

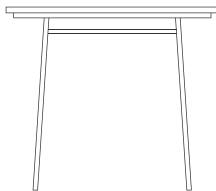

*The finished product may vary from the one on the image, depending on the combinations of materials and colors.

FACTSHEET

1730 Hanging Chair Structure

MATERIALS

IRON / Used in solid rod form or tube, hand-welded. Finished with Zinc primer and powder coated. Now introducing a double coat to enhance durability and performance.

Color Powder Coating

Indoor and outdoor use



DIMENSIONS

H 207cm / 81.5"

L 122cm / 48"

W 99cm / 39"

23 kg / 50.7 lb

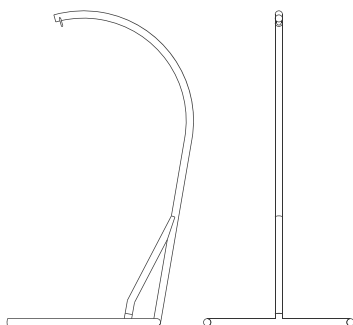

FACTSHEET

1730 Hanging Chair

MATERIALS

IRON / Used in solid rod form or tube, hand-welded. Finished with Zinc primer and powder coated. Now introducing a double coat to enhance durability and performance.

PVC / Our star material. Ideal for outdoors. Made with a percentage of recycled material, and also 100% recyclable. With added UV filters that protect color from fast-fading under the sun. It does not become dry or breakable, keeps its flexibility. Non-flammable, easy to clean.

FABRIC CORD / Synthetic nylon cord, highly weather resistant, rain or shine. Stays soft to the touch while providing great support.

FABRIC / We use Sunbrella fabric to cover our cushions. These fabrics are made from 100% solution-dyed acrylic, which make them breathable as well as UV, water, mildew and stain resistant.

Resistant to humidity and sunlight

PALM FIBER / The palm fiber we use at Mexa is specially harvested from the Mexican pacific coastline. This rope is specially threaded by twisting and interlocking the largest leaves while applying a certain amount of moisture. This material gives our pieces a very warm look and feel. **Please note: our natural palm fiber is an indoor material.**

SYNTHETIC PALM FIBER / is made out of polyethylene raw material, which was specially developed for furniture use and it stands really well in the elements. Its variety of brown tones make it look and feel like natural fiber, but with the capacity to be used in the outdoors.

Resistant to humidity and sunlight

Color Powder Coating

Indoor and outdoor use



Fabric

Indoor and outdoor use

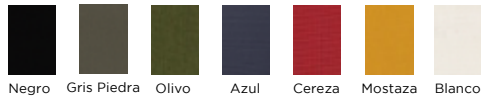

Natural Palm

Indoor use



Synthetic Palm

Indoor and outdoor use



PVC

Indoor and outdoor use

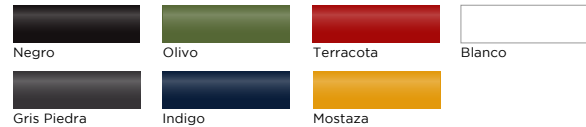

Fabric Cord

Indoor and outdoor use 7mm

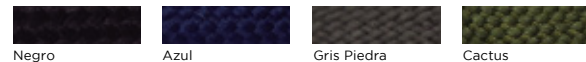

DIMENSIONS

H 126.5cm / 50"

L 87cm / 34"

W 79.6cm / 31.5"

13.3 kg / 29.2 lb

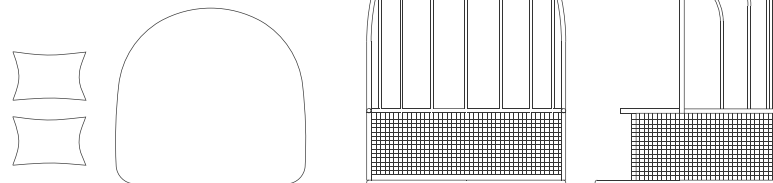

*The finished product may vary from the one on the image, depending on the combinations of materials and colors.

mexa